

- Profiller
- Profiles

Yalıtımsız Kapi ve Vitrin Serisi

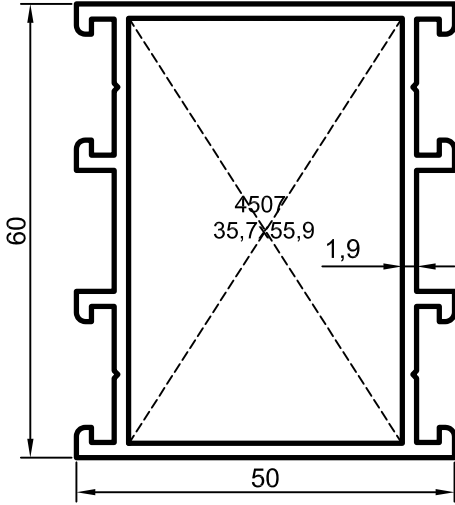

No : 4141

Kasa ve Orta $J_x=23,37 \text{ cm}^4$
1,285 kg/m $J_y=15,50 \text{ cm}^4$

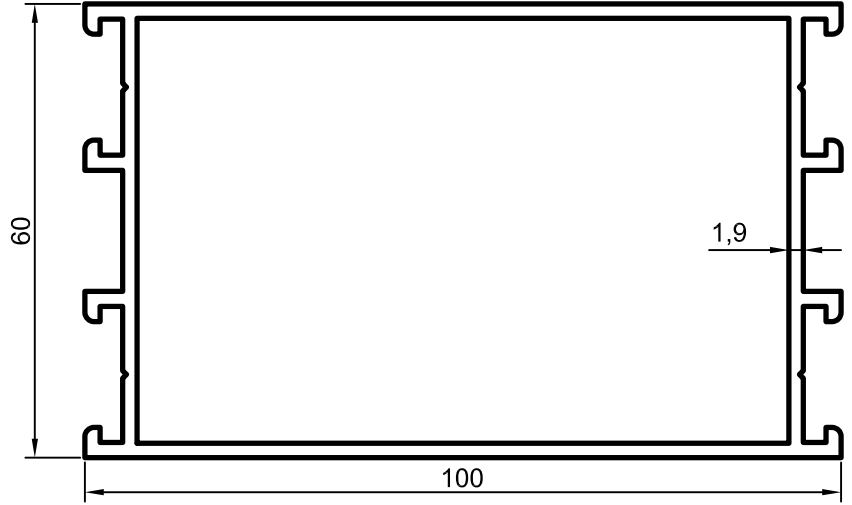

No : 4146

Geniş Kasa ve Orta $J_x=39,41 \text{ cm}^4$
1,800 kg/mt $J_y=89,47 \text{ cm}^4$

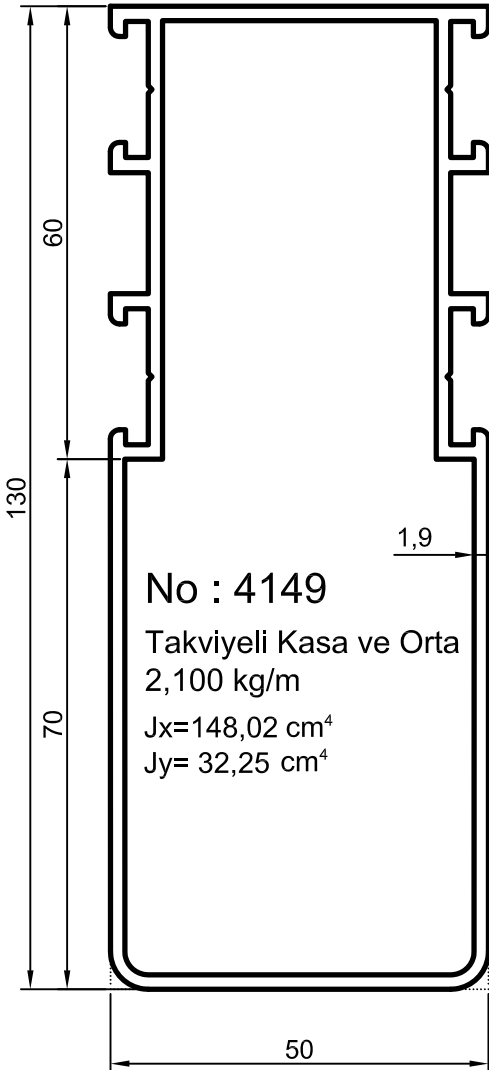

No : 4149

Takviyeli Kasa ve Orta
2,100 kg/m
 $J_x=148,02 \text{ cm}^4$
 $J_y= 32,25 \text{ cm}^4$

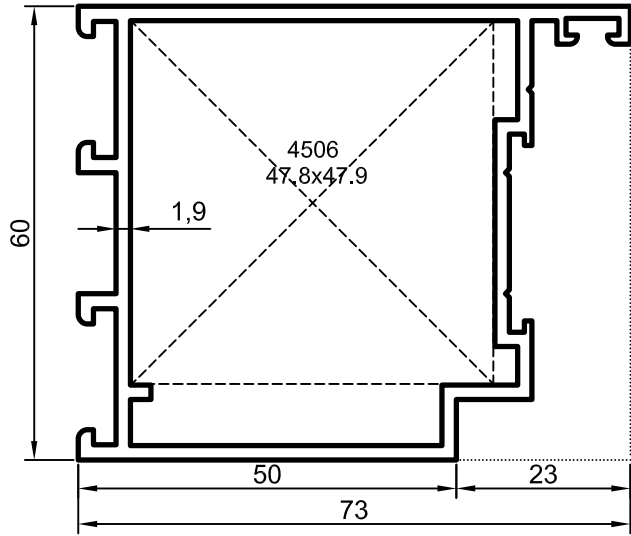

No : 4140

Kanat $J_x=33,02 \text{ cm}^4$
1,440 kg/m $J_y=24,17 \text{ cm}^4$

No : 4150

135 Dönüş prf.
1,180 kg/m

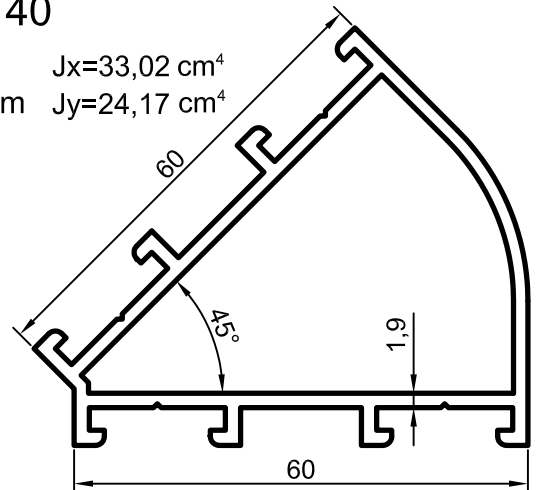

Uyarı: Profil ağırlıklarımız teorik olup; teslim anındaki tartımız geçerlidir.

- Profiller
- Profiles

Yalıtımsız Kapı ve Vitrin Serisi

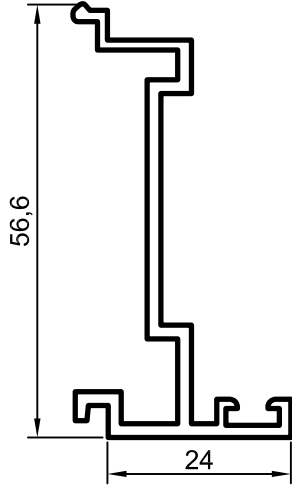

No : 4143

Kanat Adaptörü
0,550 kg/m

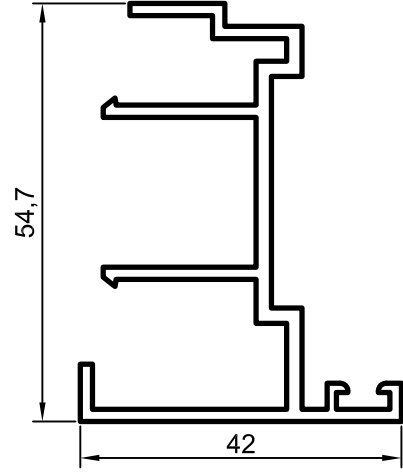

No : 4147

Çift Kanat Adaptörü
0,840 kg/m

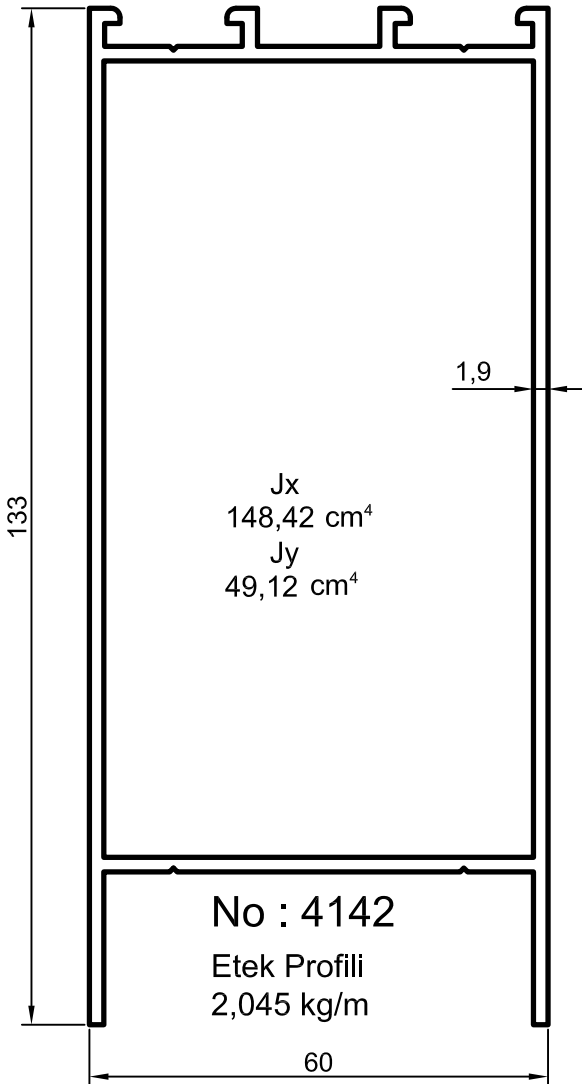

No : 4142

Etek Profili
2,045 kg/m

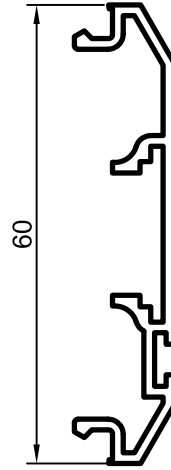

No : 4148

Çarpma Kapı Adaptörü
0,430 kg/m

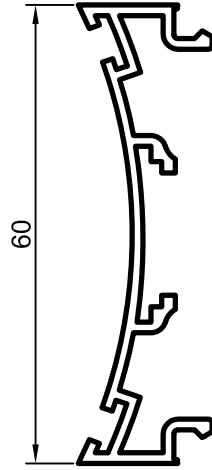

No : 4148-D

Çarpma Kapı Adaptörü
0,505 kg/m

Uyarı: Profil ağırlıklarımız teorik olup; teslim anındaki tartımız geçerlidir.

- Profiller
- Profiles

Yalıtımsız Kapı ve Vitrin Serisi

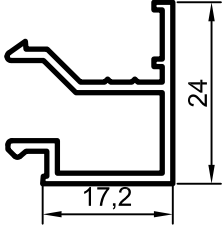

No : 4144
Cam Çıtası
0,290 kg/m

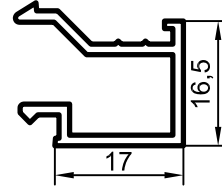

No : 4145
Cam Çıtası
0,255 kg/m

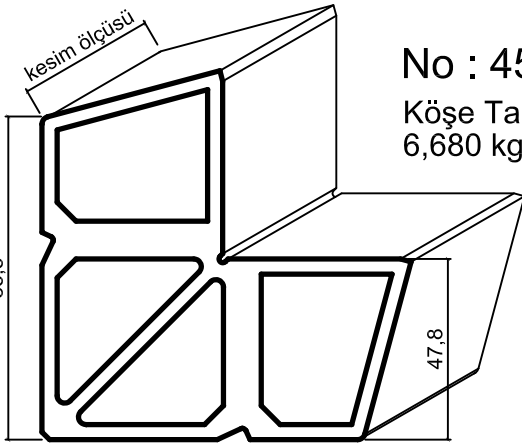
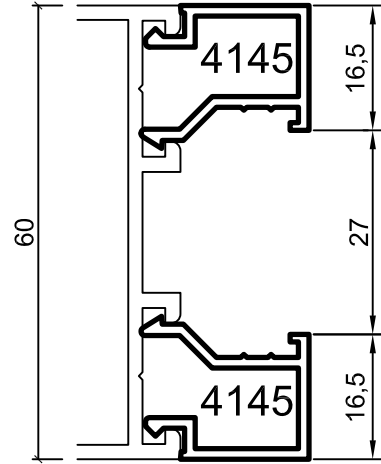
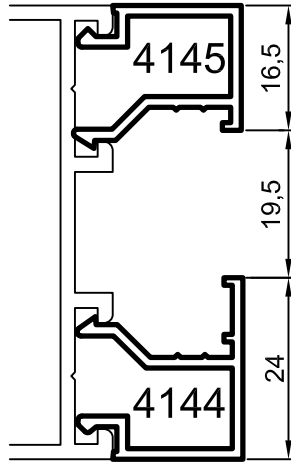
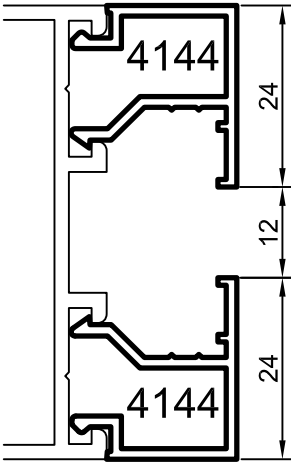

No : 4506
Köşe Takozu
6,680 kg/m

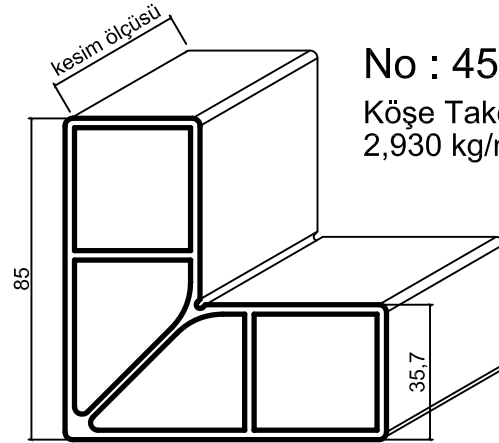

No : 4507
Köşe Takozu
2,930 kg/m

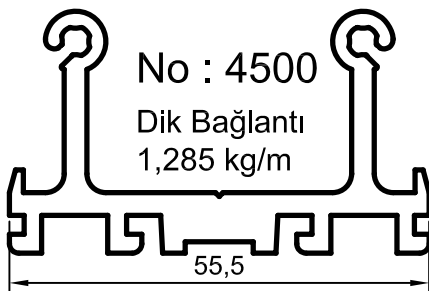

No : 4500
Dik Bağlantı
1,285 kg/m

Ölçek: 1/1, 1/2

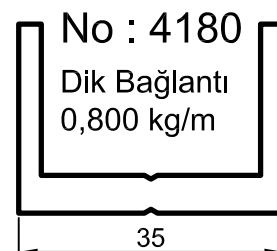

No : 4180
Dik Bağlantı
0,800 kg/m

Uyarı: Profil ağırlıklarımız teorik olup; teslim anındaki tartımız geçerlidir.

Dikkat : Köşeler preslenmeden önce mutlaka takozlarına epoksi tatbikatı uygulanmalıdır.

- Aksesuarlar
- Accessories

Yalıtımsız Kapı ve Vitrin Serisi

SİSTEM FİTİLLERİ VE AKSESUARLARI

Çizim	Aksesuar Kodu	Malzeme	Açıklama	Koli / Paket
	Epil 5-2	EPDM	İç Cam Fitili ' 2 mm '	400 m/koli
	Epil 5-3	EPDM	İç Cam Fitili ' 3 mm '	370 m/koli
	Epil 5-4	EPDM	İç Cam Fitili ' 4 mm '	270 m/koli
	Epil 5-5	EPDM	İç Cam Fitili ' 5 mm '	230 m/koli
	Epil 62	EPDM	T60 Bini Fitili	450 m/koli
	SDKM-57-076	Alüminyum	Düz Kapazlama Mentеше (Beyaz Boyalı , Renkli Boyalı, Mat/Parlak Eloksalli)	10 ad/pk
		Alüminyum	T60 Makaralı/Dilli Kilit Karşılığı (Beyaz Boyalı , Renkli Boyalı, Mat/Parlak Eloksalli)	İstenilen Miktarda

- Detaylar
- Details

Yalıtımsız Kapi ve Vitrin Serisi

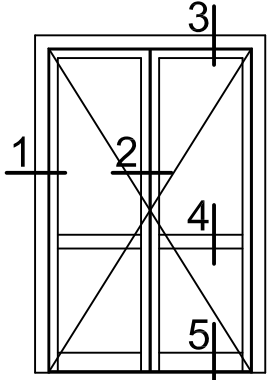

İÇE AÇILIR KAPI
DOOR - INSIDE OPENING

Detay 1
Detail

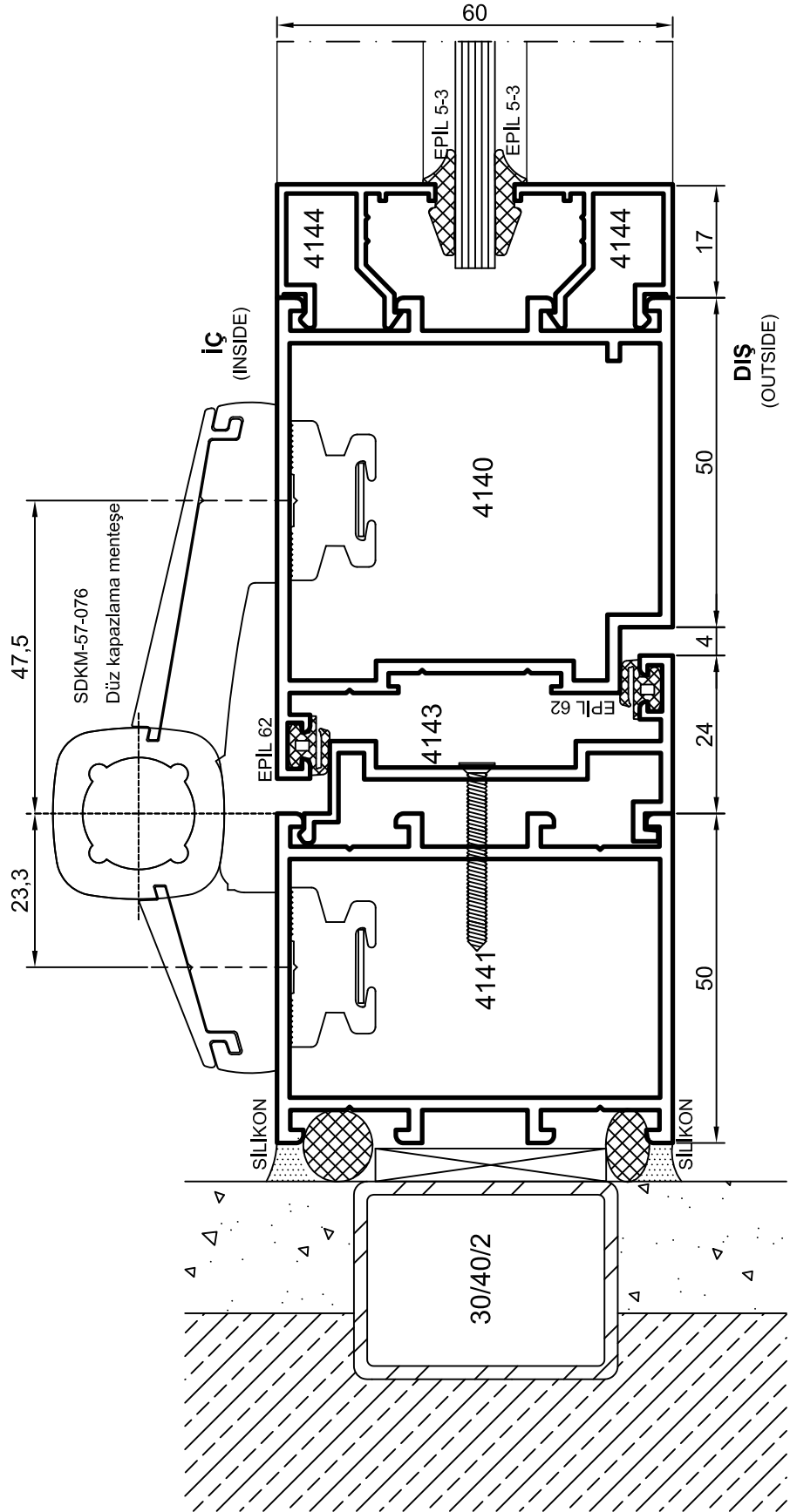

- Detaylar
- Details

Yalıtımsız Kapi ve Vitrin Serisi

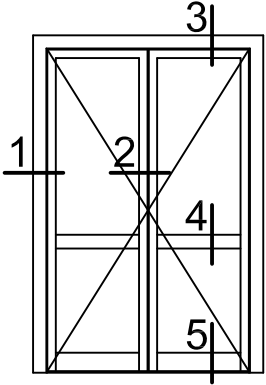

İÇE AÇILIR KAPI
DOOR - INSIDE OPENING

Detay 2
Detail

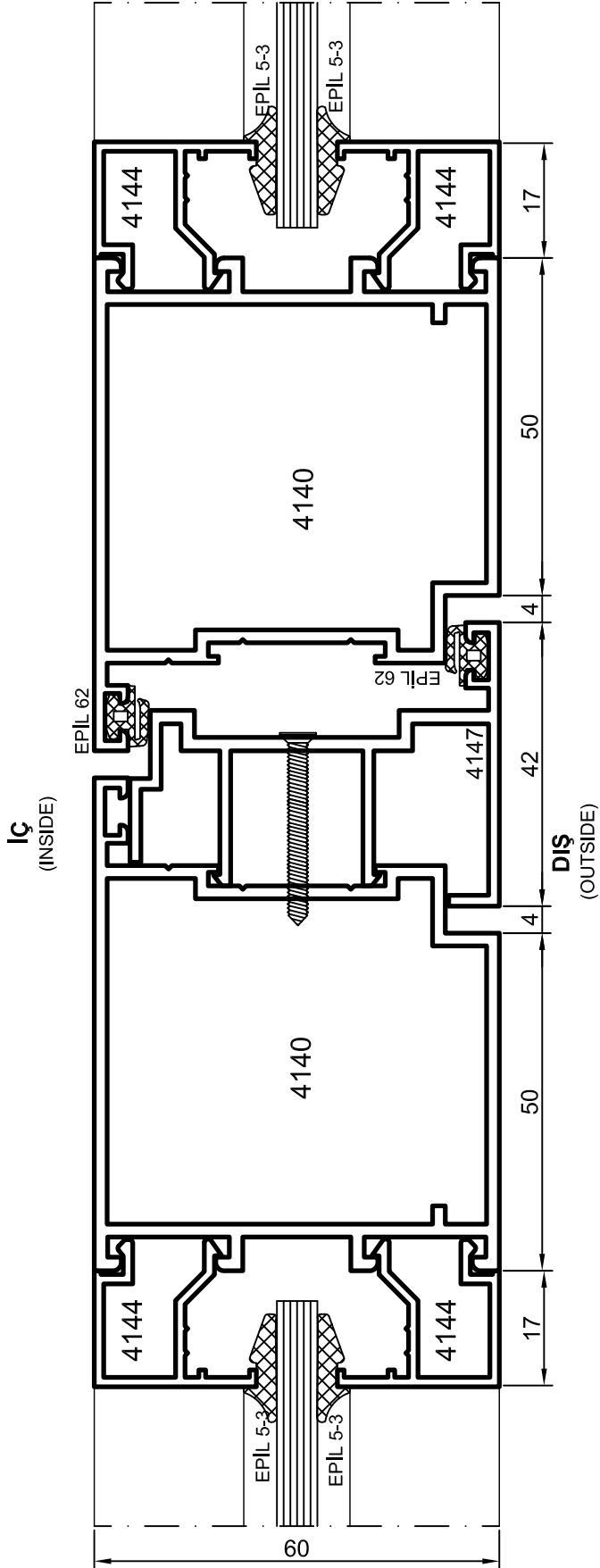

- Detaylar
- Details

Yalıtımsız Kapi ve Vitrin Serisi

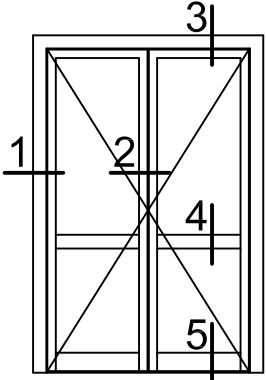

İÇE AÇILIR KAPI
DOOR - INSIDE OPENING

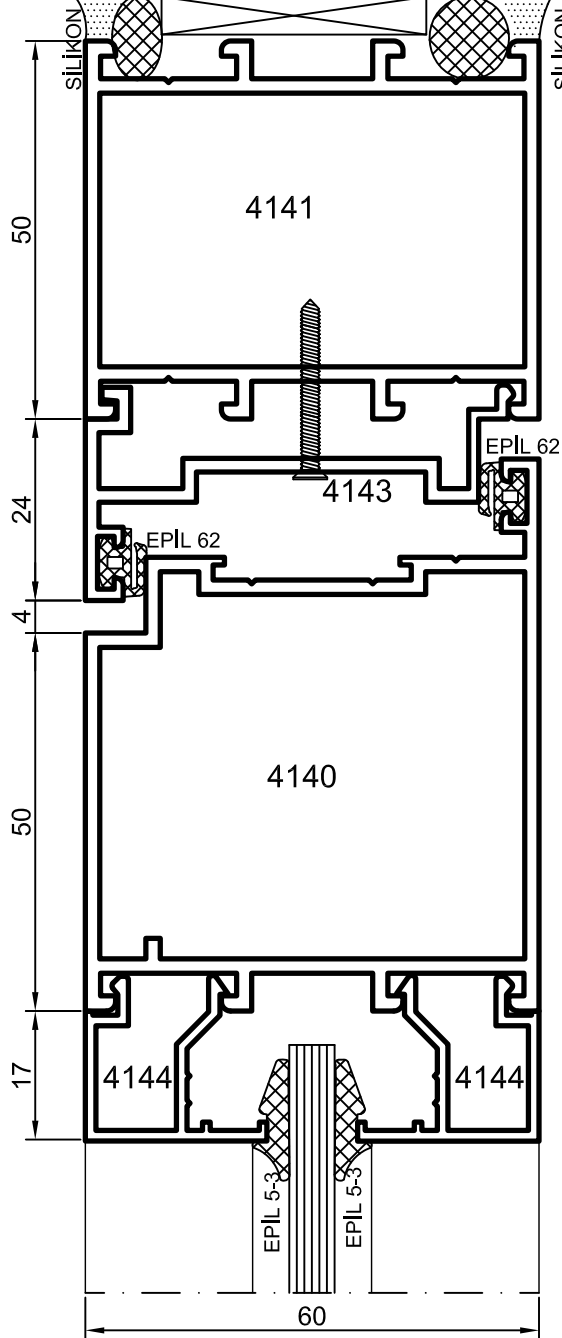
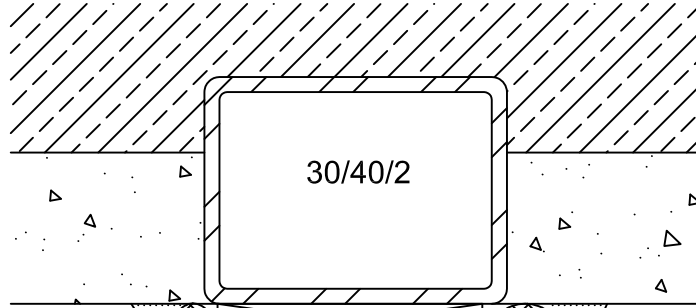

DİŞ
(OUTSIDE)

İÇ
(INSIDE)

Detay
Detail 3

- Detaylar
- Details

Yalıtımsız Kapi ve Vitrin Serisi

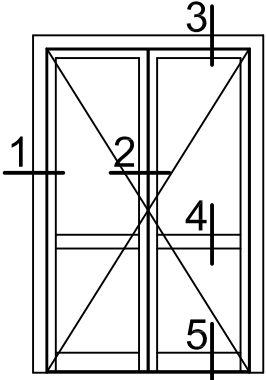

İÇE AÇILIR KAPI
DOOR - INSIDE OPENING

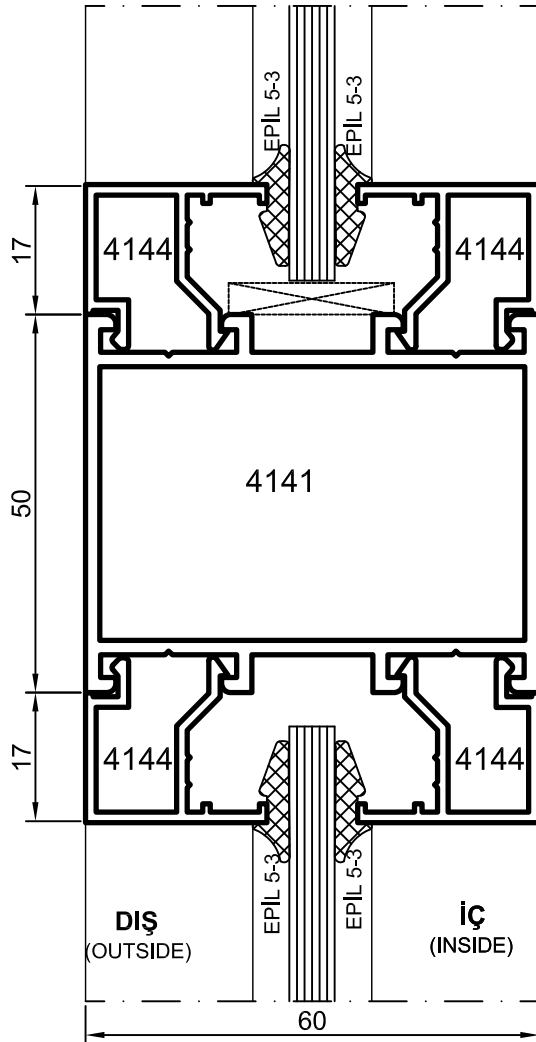

Detay
Detail 4

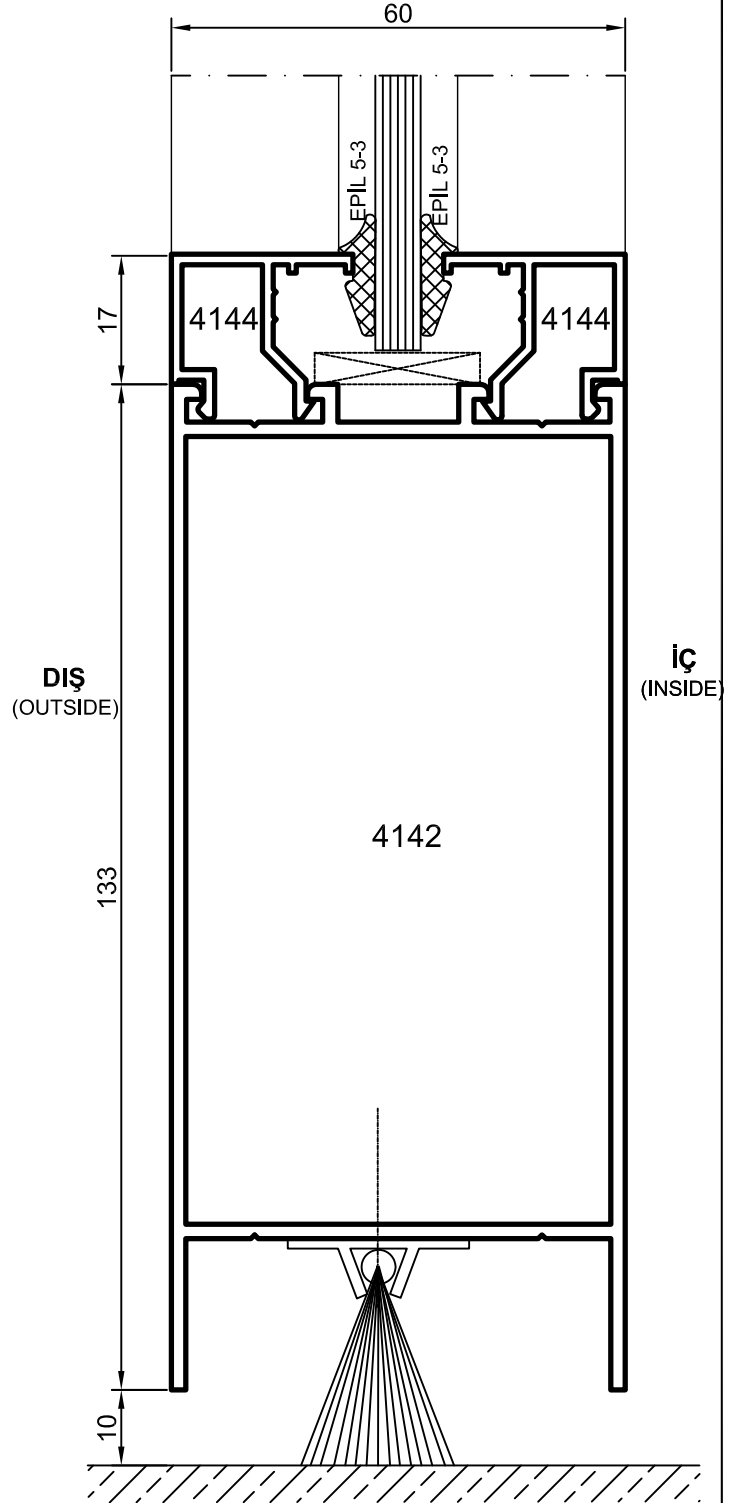

Detay
Detail 5

- Detaylar
- Details

Yalıtımsız Kapi ve Vitrin Serisi

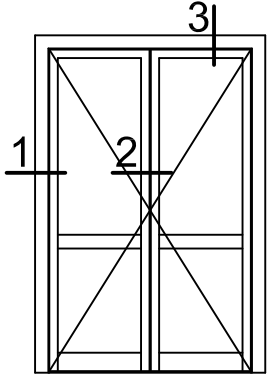

ÇARPMA KAPI
SWING DOOR

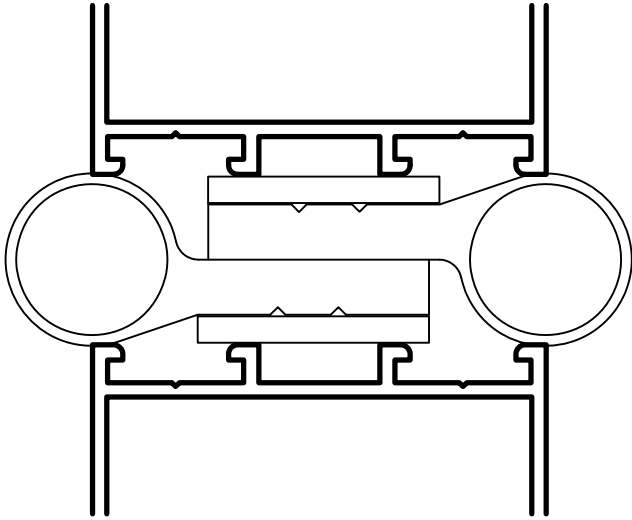

Detay 1
Detail

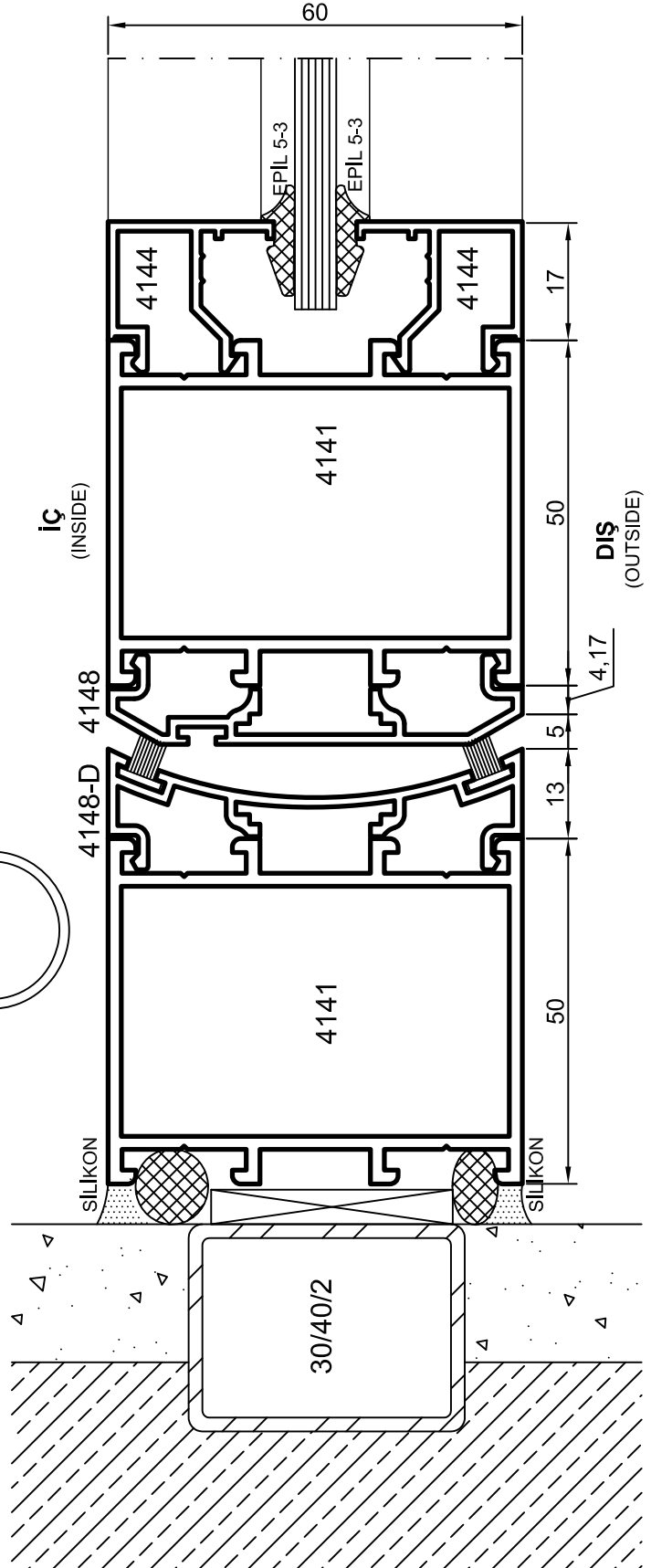

- Detaylar
- Details

Yalıtımsız Kapi ve Vitrin Serisi

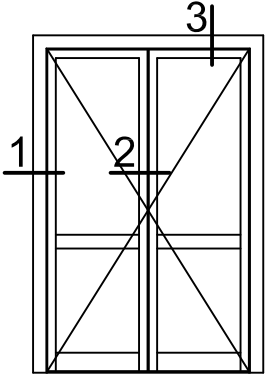

ÇARPMA KAPI
SWING DOOR

Detay 2
Detail

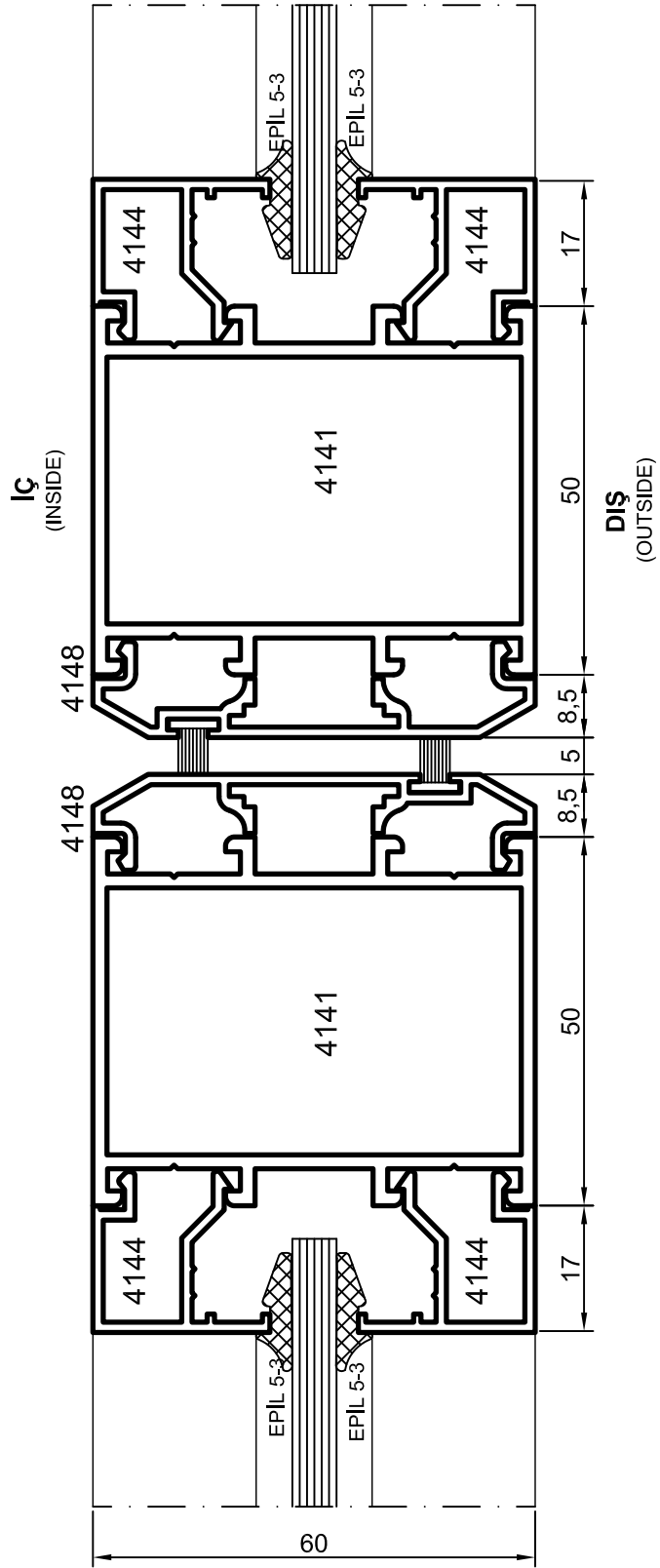

- Detaylar
- Details

Yalıtımsız Kapi ve Vitrin Serisi

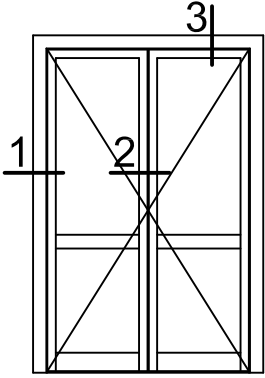

ÇARPMA KAPI
SWING DOOR

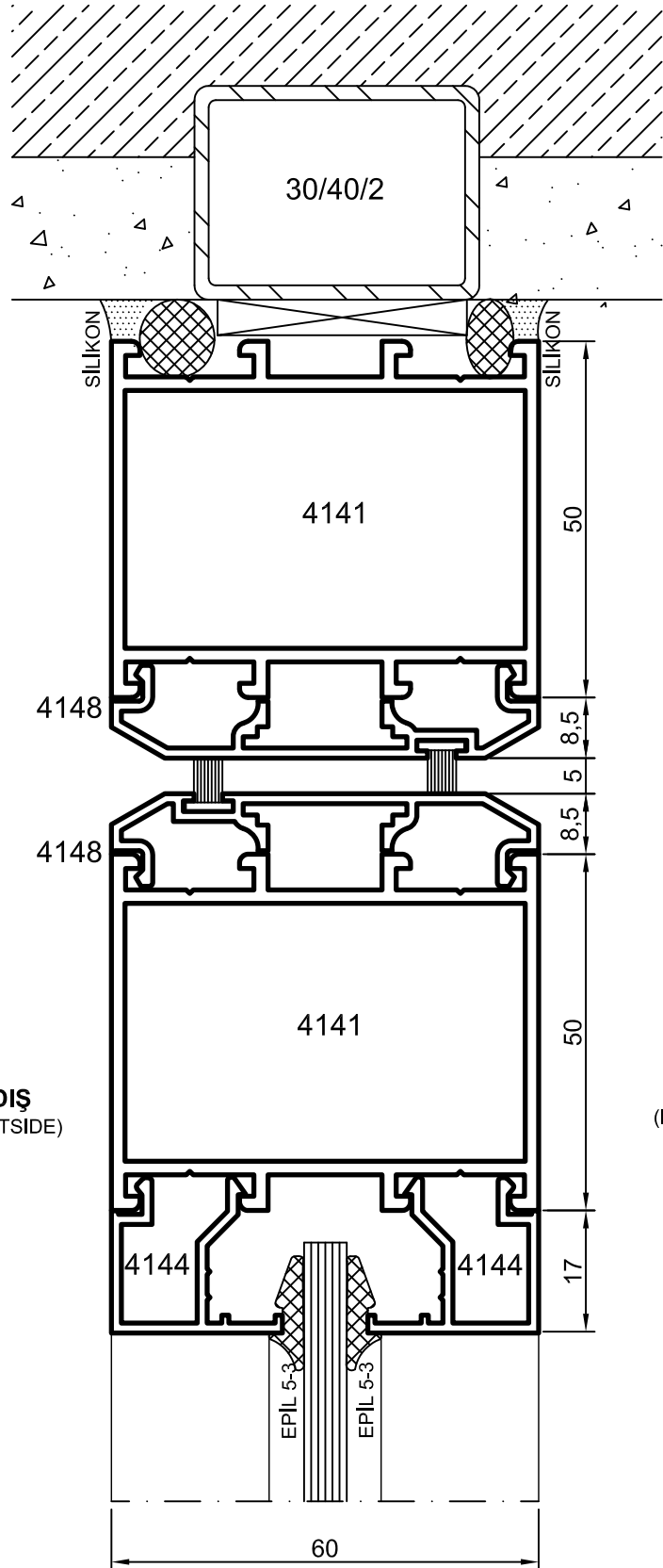

Detay 3
Detail 3

- Detaylar
- Details

Yalıtımsız Kapi ve Vitrin Serisi

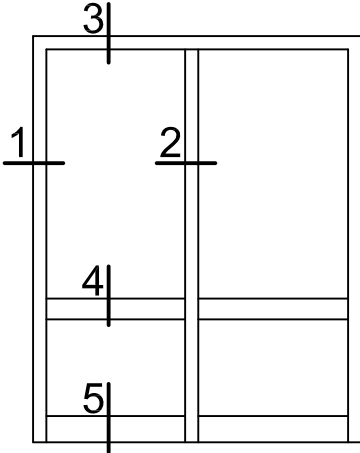

VİTRİN DOĞRAMASI

Detay
Detail 1

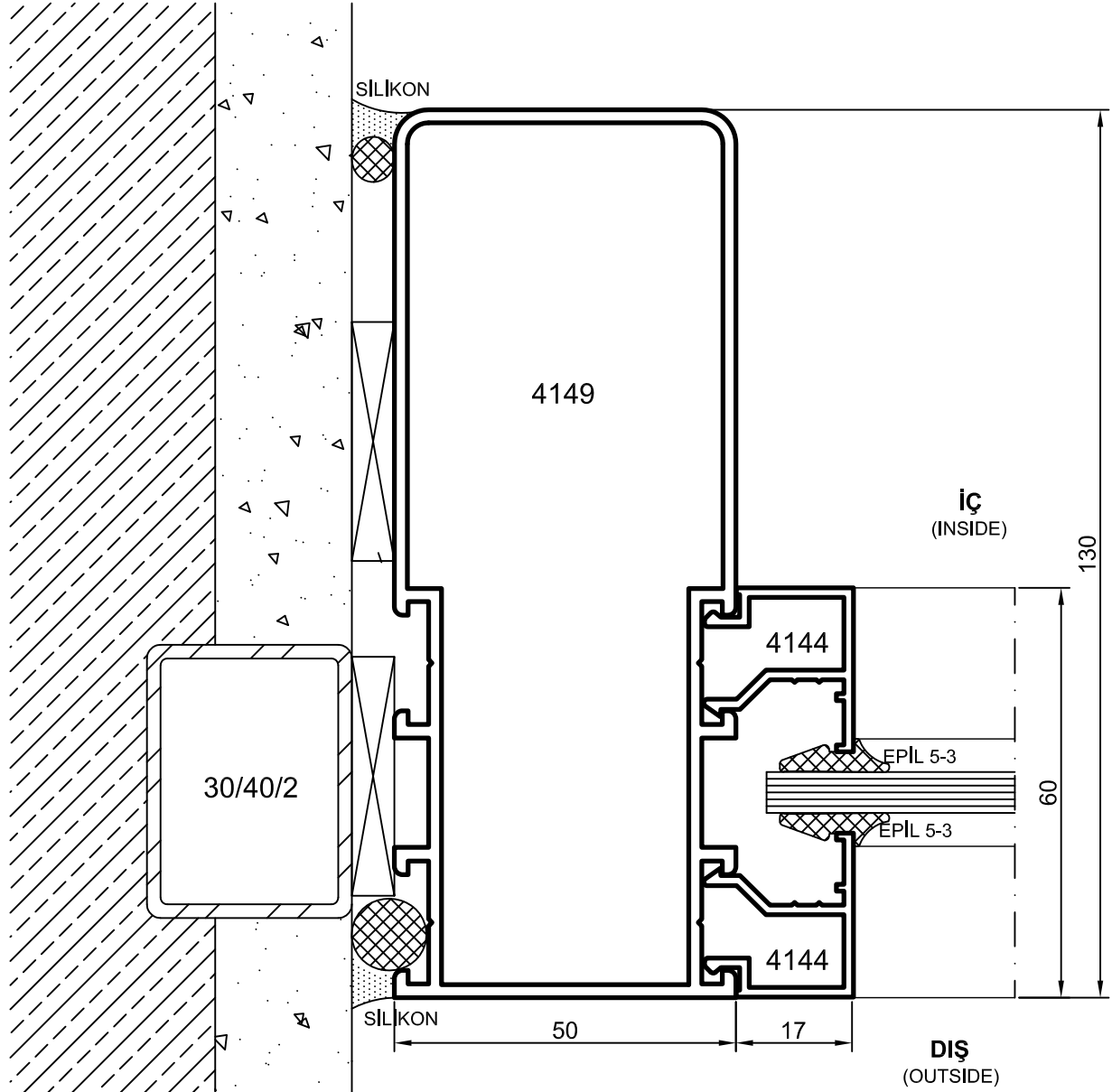

- Detaylar
- Details

Yalıtımsız Kapı ve Vitrin Serisi

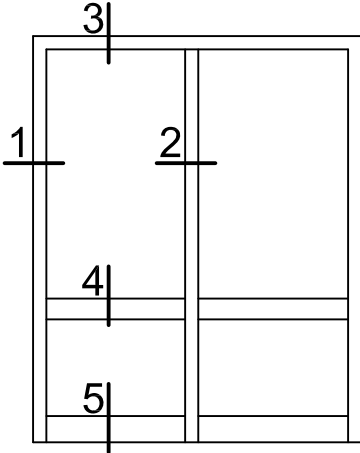

VİTRİN DOĞRAMASI

Detay
Detail 2

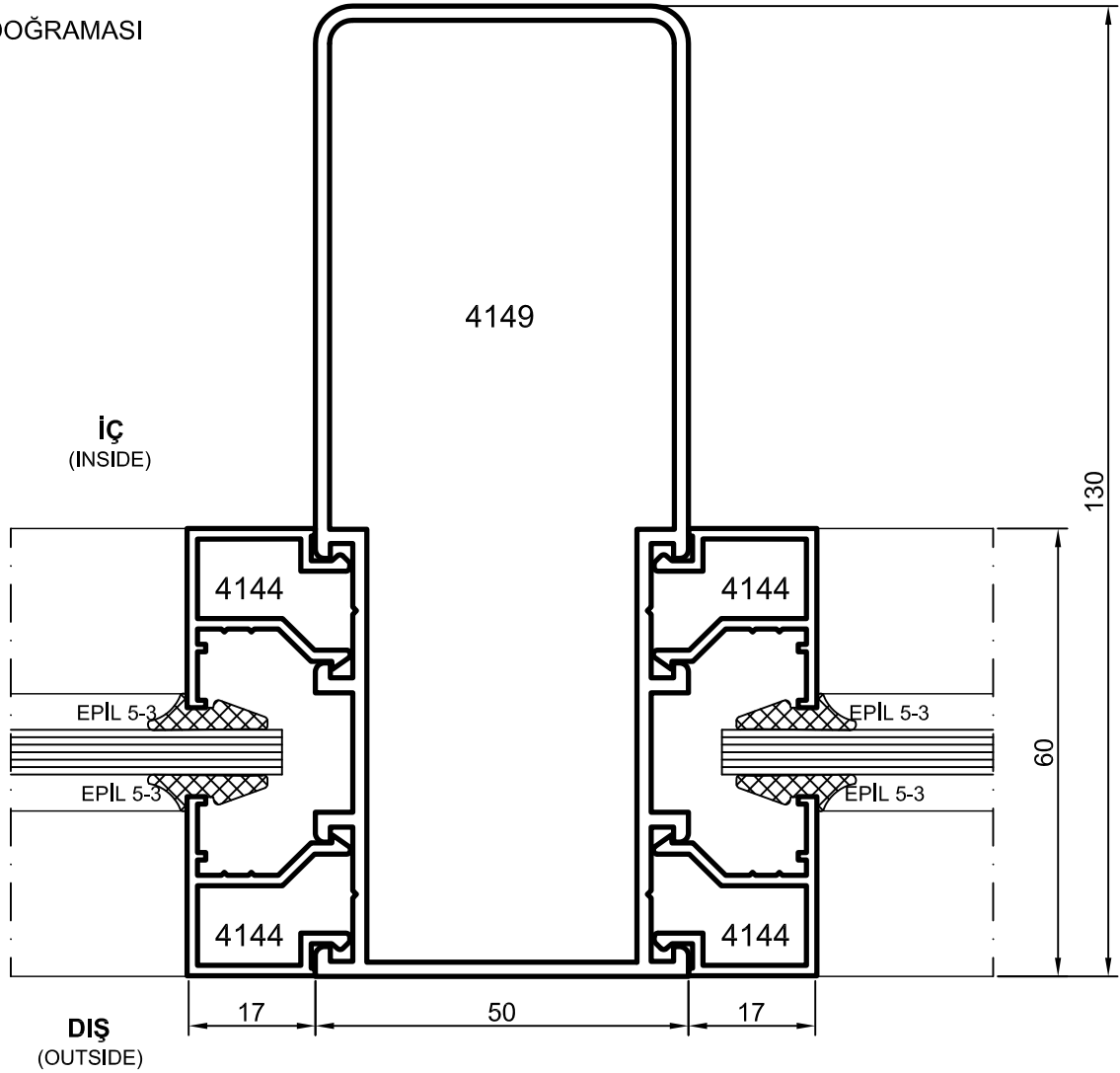

- Detaylar
- Details

Yalıtımsız Kapi ve Vitrin Serisi

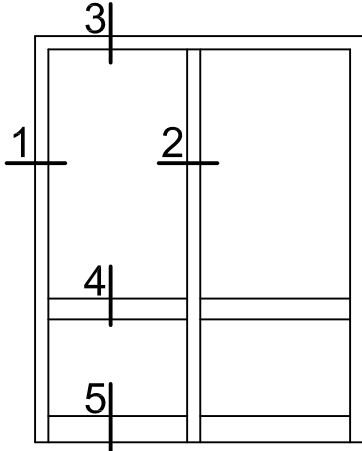

VİTRİN DOĞRAMASI

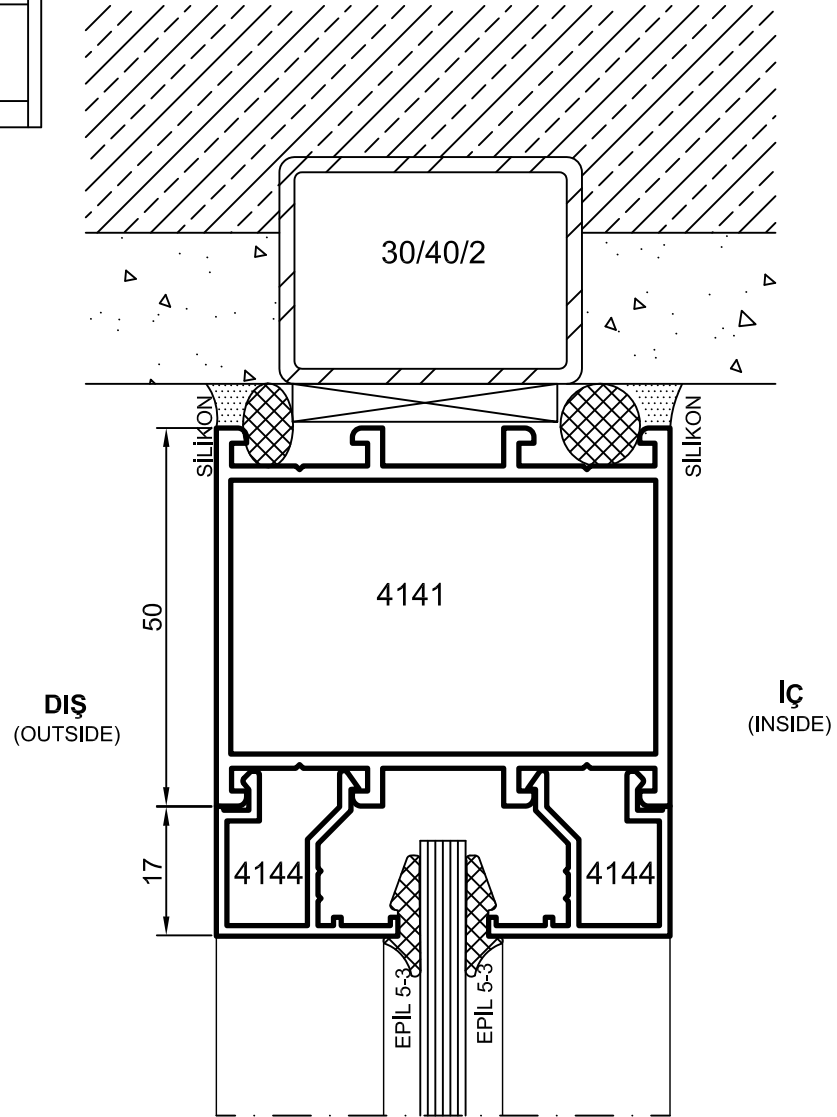

Detay
Detail 3

- Detaylar
- Details

Yalıtımsız Kapı ve Vitrin Serisi

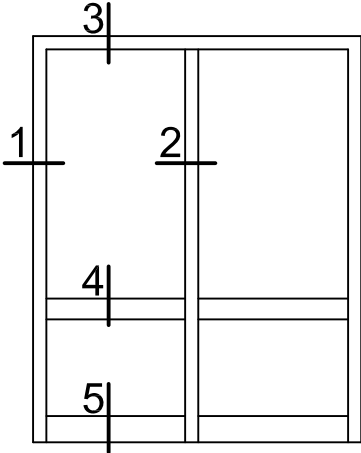

VİTRİN DOĞRAMASI

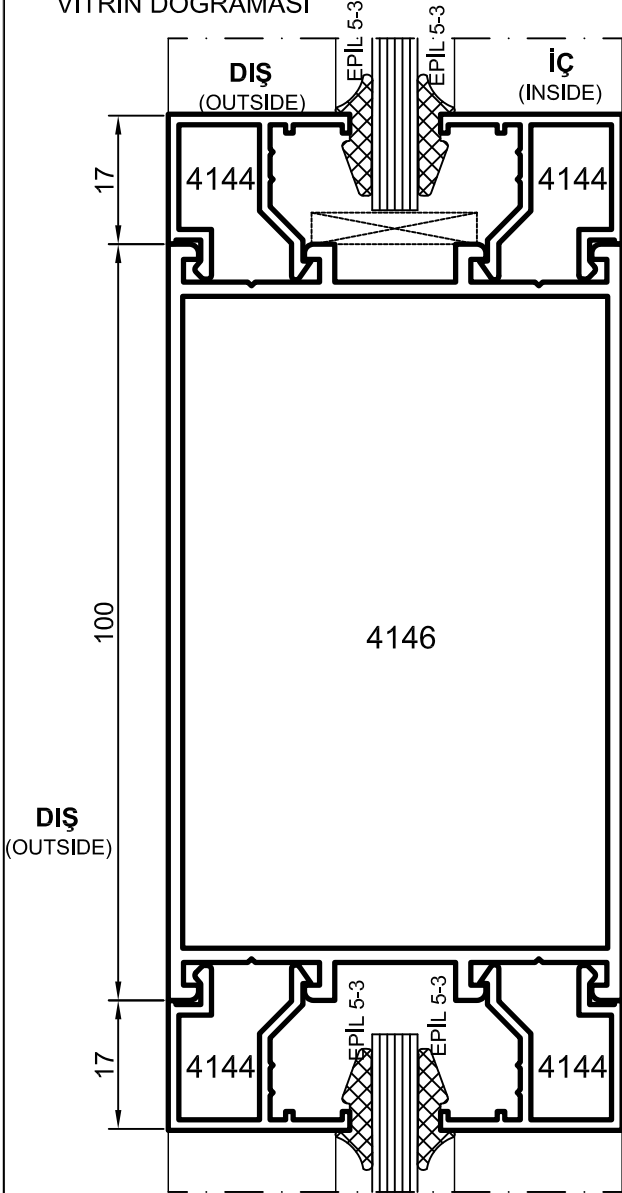

Detay
Detail 4

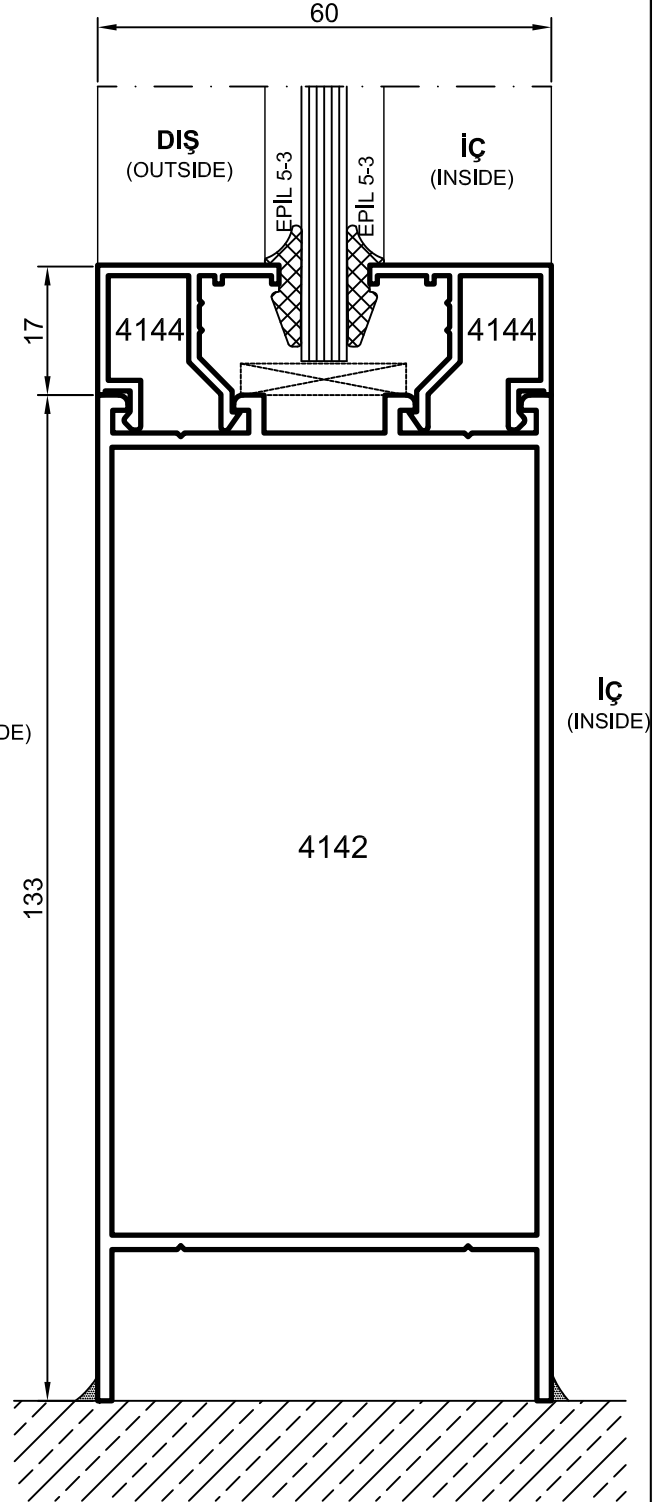

Detay
Detail 5